

NPN-Silizium-Fototransistor in SMR[®] Gehäuse Silicon NPN Phototransistor in SMR[®] Package

SFH 3500/FA
SFH 3505/FA

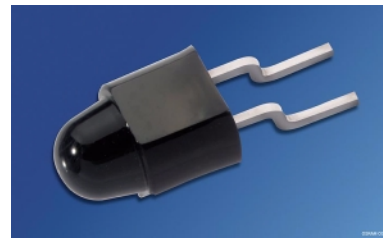

SFH 3500



SFH 3500FA



SFH 3505



SFH 3505FA

Wesentliche Merkmale

- Speziell geeignet für Anwendungen im Bereich von 450 nm bis 1060 nm (SFH 3500/3505) und bei 880 nm (SFH 3500 FA/3505 FA)
- SMR[®] (Surface Mount Radial) Gehäuse
- Hohe Empfindlichkeit
- Auf PCB aufsetzbar (SFH 3500/FA) oder in PCB einlegbar (SFH 3505/FA)
- Passend zu IRED SFH 451x, SFH 458x
- Für Oberflächenmontage (SMT) geeignet
- Gegurtet lieferbar

Anwendungen

- Fertigungs- und Kontrollanwendungen der Industrie
- „Messen/Steuern/Regeln“
- Lichtschranken für Gleich- und Wechsellichtbetrieb

Features

- Especially suitable for applications from 450 nm to 1060 nm (SFH 3500/3505) and of 880 nm (SFH 3500 FA/3505 FA)
- SMR[®] (Surface Mount Radial) package
- High sensitivity
- For mounting on pcb (SFH 3500/FA) or in pcb (SFH 3505/FA)
- Matches IRED SFH 451x, SFH 458x
- Suitable for surface mounting (SMT)
- Available on tape and reel

Applications

- A variety of manufacturing and monitoring applications
- For control and drive circuits
- Photointerrupters

Typ Type	Bestellnummer Ordering Code	Gehäuse Package
SFH 3500	Q62702-P5031	5-mm-SMR [®] -Gehäuse (T 1 3/4), klares (SFH 3500/3505) und schwarz eingefärbtes (SFH 3500 FA/3505 FA) Epoxy-Gießharz, Anschlüsse (SFH 3500/3500 FA gebogen, SFH 3505/3505 FA gerade) im 2.54-mm-Raster (1/10"), Kathodenkennzeichnung: siehe Maßzeichnung. 5 mm SMR [®] package (T 1 3/4), clear (SFH 3500/3505) and black-colored (SFH 3500 FA/3505 FA) epoxy resin, solder tabs (SFH 3500/3500 FA bent, SFH 3505/3505 FA straight) lead spacing 2.54 mm (1/10"), cathode marking: see package outline.
SFH 3500-3/4	Q62702-P5205	
SFH 3500-5/6	Q62702-P5206	
SFH 3505	Q62702-P5050	
SFH 3505-3/4	Q62702-P5207	
SFH 3505-5/6	Q62702-P5208	
SFH 3500 FA	Q62702-P5032	
SFH 3500 FA-3/4	Q62702-P5201	
SFH 3500 FA-5/6	Q62702-P5202	
SFH 3505 FA	Q62702-P5051	
SFH 3505 FA-3/4	Q62702-P5203	
SFH 3505 FA-5/6	Q62702-P5204	

**Grenzwerte
Maximum Ratings**

Bezeichnung Parameter	Symbol Symbol	Wert Value	Einheit Unit
Betriebs- und Lagertemperatur Operating and storage temperature range	$T_{op}; T_{stg}$	- 40 ... + 85	°C
Kollektor-Emitterspannung Collector-emitter voltage	V_{CE} $V_{CE} (t < 2 \text{ min})$	35 70	V V
Kollektorstrom Collector current	I_C	50	mA
Kollektorspitzenstrom, $\tau < 10 \mu\text{s}$ Collector surge current	I_{CS}	100	mA
Emitter-Kollektorspannung Emitter-collector voltage	V_{EC}	7	V
Verlustleistung, $T_A = 25 \text{ }^\circ\text{C}$ Total power dissipation	P_{tot}	150	mW
Wärmewiderstand Thermal resistance	R_{thJA}	400	K/W

Kennwerte ($T_A = 25\text{ °C}$, $\lambda = 950\text{ nm}$)

Characteristics

Bezeichnung Parameter	Symbol Symbol	Wert Value		Einheit Unit
		SFH 350x	SFH 350x FA	
Wellenlänge der max. Fotoempfindlichkeit Wavelength of max. sensitivity	$\lambda_{S\text{ max}}$	830	860	nm
Spektraler Bereich der Fotoempfindlichkeit $S = 10\%$ von S_{max} Spectral range of sensitivity $S = 10\%$ of S_{max}	λ	450 ... 1060	740 ... 1070	nm
Bestrahlungsempfindliche Fläche Radiant sensitive area	A	0.55	0.55	mm ²
Abmessungen der Chip-Fläche Dimension of chip area	$L \times B$ $L \times W$	1.00 × 1.00		mm × mm
Halbwinkel Half angle	φ	± 13		Grad deg.
Kapazität, $V_{\text{CE}} = 5\text{ V}$, $f = 1\text{ MHz}$, $E = 0$ Capacitance	C_{CE}	10		pF
Dunkelstrom, $V_{\text{CE}} = 20$ Dark current	I_{CEO}	3 (< 200)		nA

Die Fototransistoren werden nach ihrer Fotoempfindlichkeit gruppiert und mit arabischen Ziffern gekennzeichnet.

The phototransistors are grouped according to their spectral sensitivity and distinguished by arabian figures.

Bezeichnung Parameter	Symbol Symbol	Wert Value				Einheit Unit
		-3	-4	-5	-6	
Fotostrom Photocurrent $E_e = 0.5 \text{ mW/cm}^2$, $V_{CE} = 5 \text{ V}$, $\lambda = 950 \text{ nm}$ SFH 3500/05: $E_v = 1000 \text{ lx}$, Normlicht/ standard light A, $V_{CE} = 5 \text{ V}$	I_{PCE}	2.5 ... 5.0 13.5	4.0 ... 8.0 21.5	6.3 ... 12.5 34.0	10.0 ... 20.0 51.0	mA
Anstiegszeit/Abfallzeit Rise and fall time $R_L = 1 \text{ k}\Omega$, $V_{CC} = 5 \text{ V}$, $\lambda = 950 \text{ nm}$, $I_C = 1 \text{ mA}$	t_r, t_f	14	17	20	24	μs
Kollektor-Emitter- Sättigungsspannung Collector-emitter saturation voltage $I_C = I_{PCEmin}^{1)} \times 0.3$, $E_e = 0.5 \text{ mW/cm}^2$	V_{CEsat}	150 (< 200)	150 (< 200)	150 (< 200)	150 (< 200)	mV

1) I_{PCEmin} ist der minimale Fotostrom der jeweiligen Gruppe.

1) I_{PCEmin} is the min. photocurrent of the specified group.

Photocurrent $I_{PCE} = f(V_{CE})$, $E_e = \text{Parameter}$

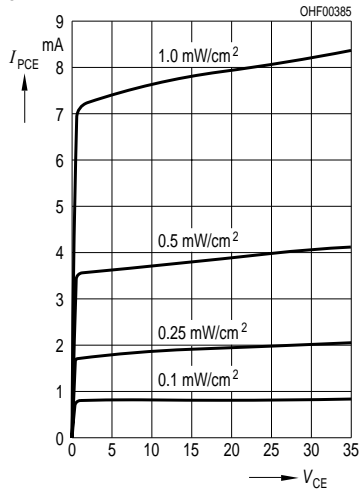

Relative Spectral Sensitivity, $S_{rel} = f(\lambda)$, SFH 3500 FA/3505 FA

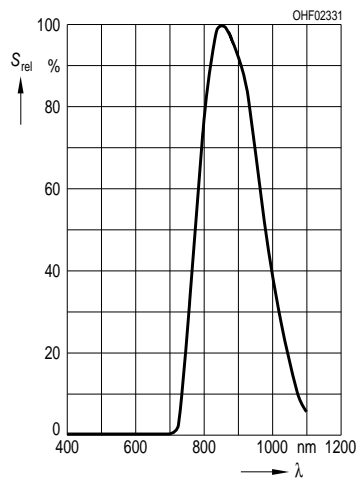

Photocurrent $I_{PCE} / I_{PCE25^\circ} = f(T_A)$, $V_{CE} = 5 \text{ V}$

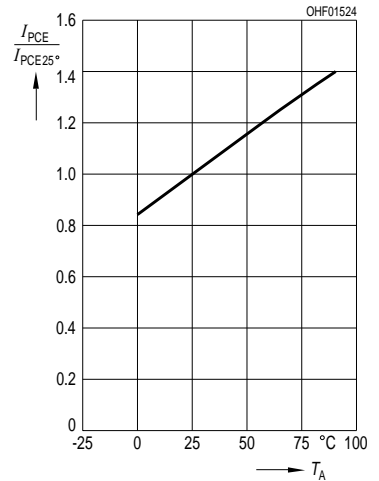

Photocurrent $I_{PCE} = f(V_{CE})$, $E_e = \text{Parameter}$

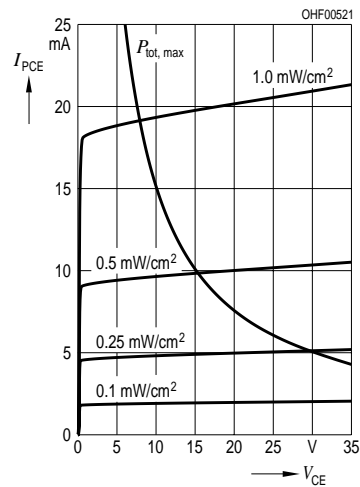

Photocurrent $I_{PCE} = f(E_e)$, $V_{CE} = 5 \text{ V}$

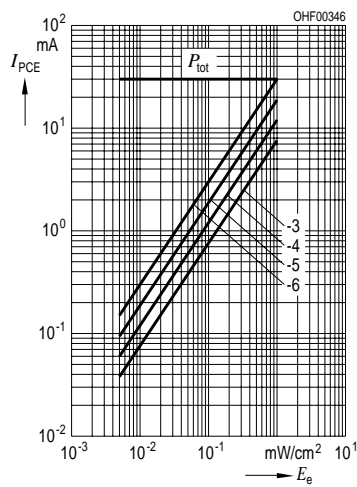

Dark Current $I_{CEO} = f(V_{CE})$, $E = 0$

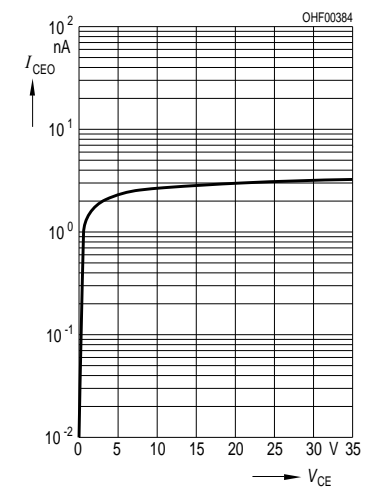

Relative Spectral Sensitivity, $S_{rel} = f(\lambda)$, SFH 3500/3505

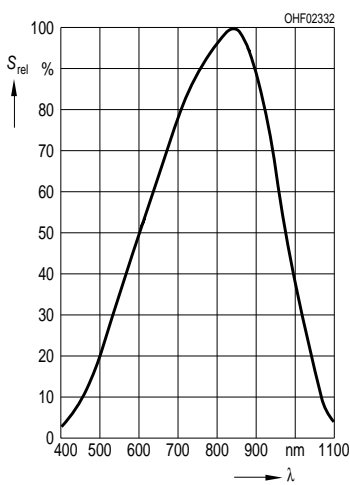

Total Power Dissipation $P_{tot} = f(T_A)$

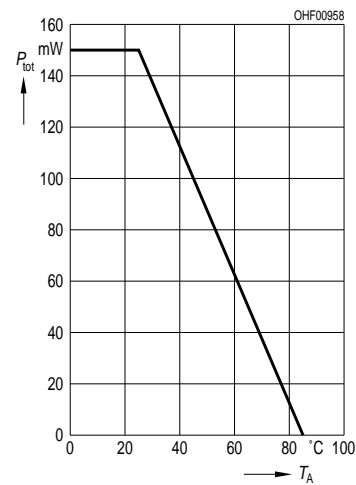

Dark Current $I_{CEO} = f(T_A)$, $V_{CE} = 20 \text{ V}$, $E = 0$

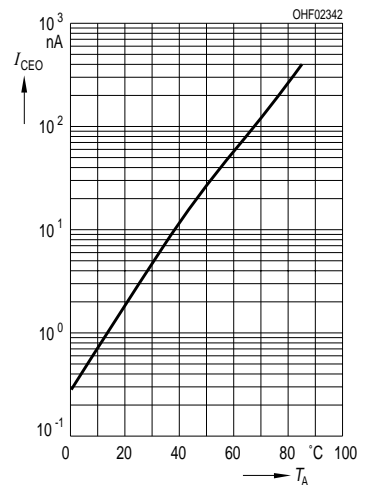

Directional Characteristics

$S_{rel} = f(\varphi)$

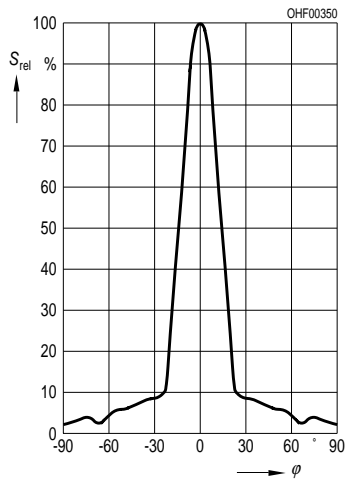

Capacitance

$C_{CE} = f(V_{CE}), f = 1 \text{ MHz}, E = 0$

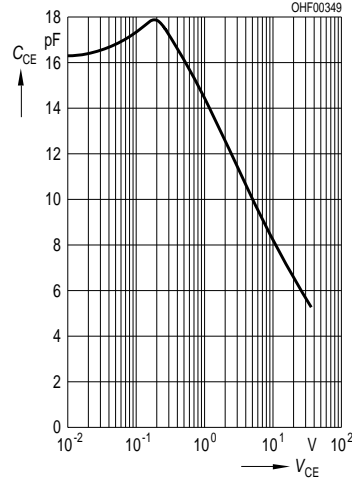

Maßzeichnung
Package Outlines

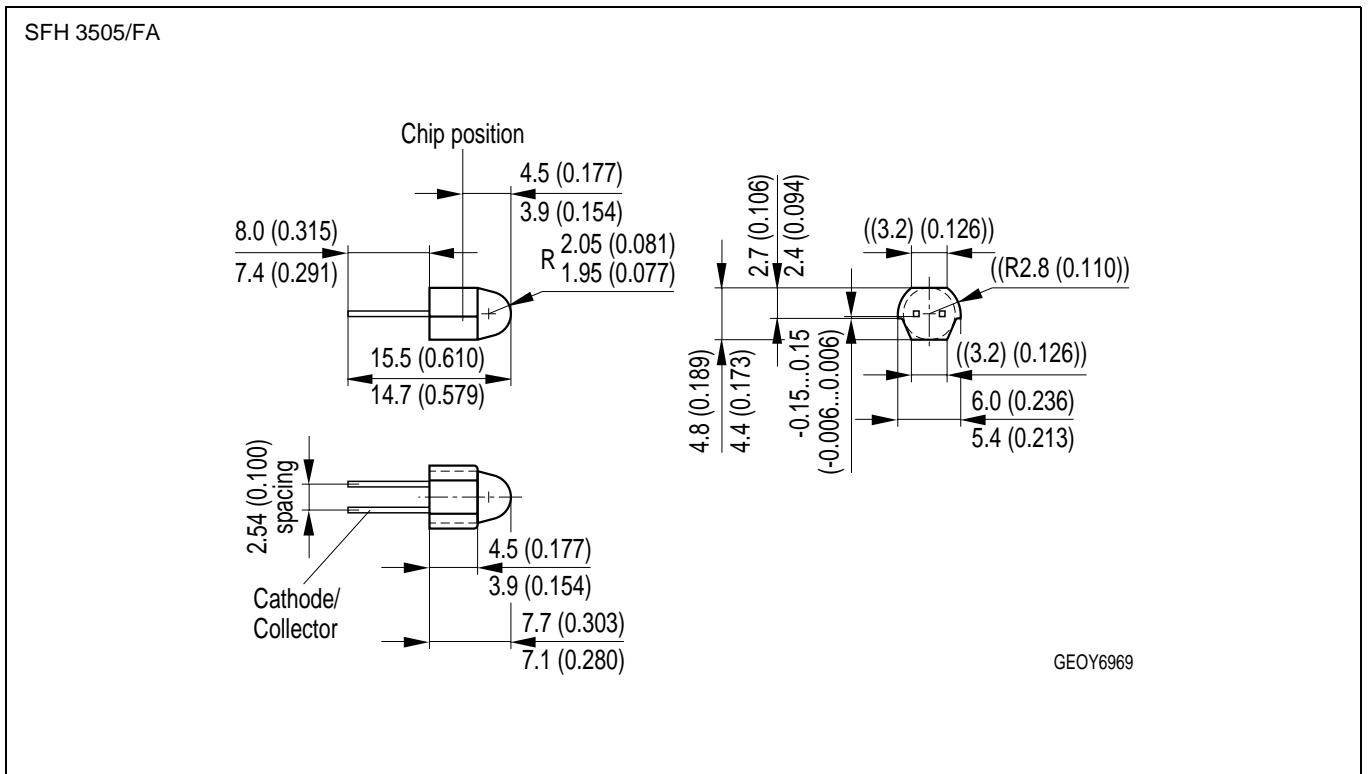
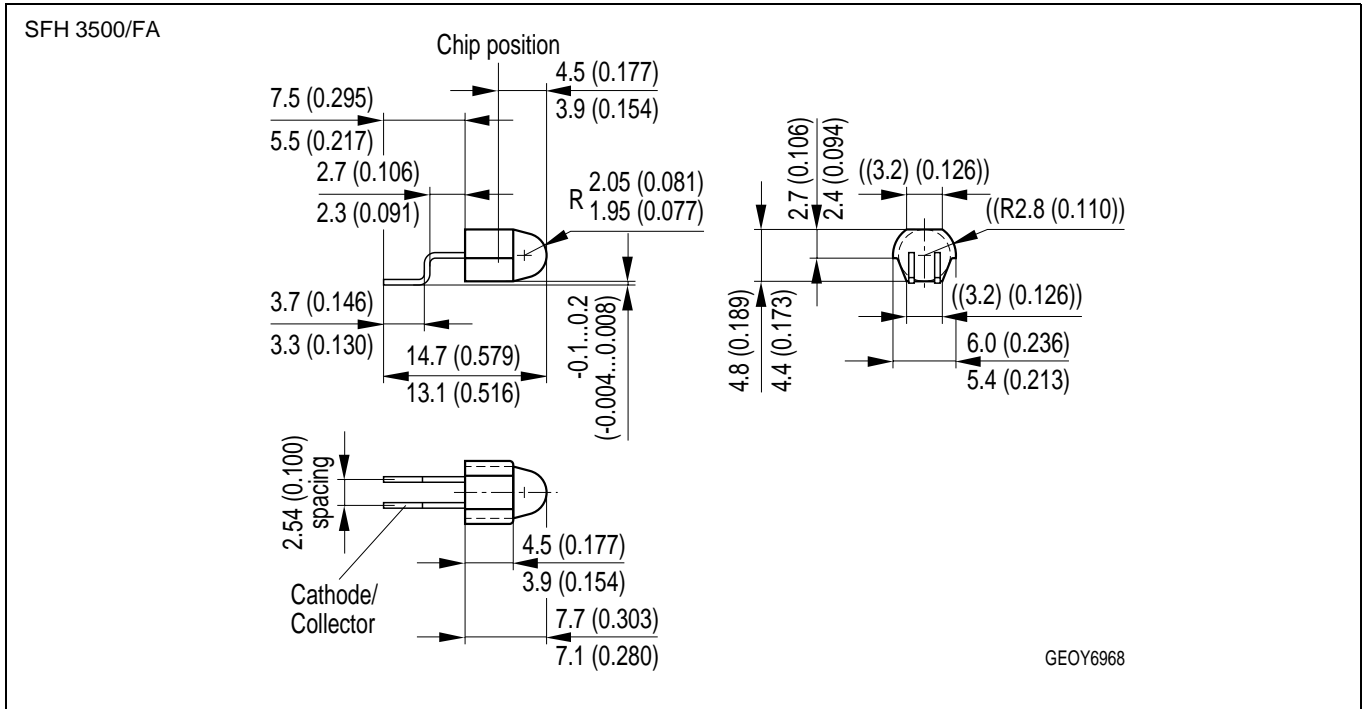

Maße werden wie folgt angegeben: mm (inch) / Dimensions are specified as follows: mm (inch).

Published by OSRAM Opto Semiconductors GmbH & Co. OHG
Wernerwerkstrasse 2, D-93049 Regensburg

© All Rights Reserved.

Attention please!

The information describes the type of component and shall not be considered as assured characteristics. Terms of delivery and rights to change design reserved. Due to technical requirements components may contain dangerous substances. For information on the types in question please contact our Sales Organization.

Packing

Please use the recycling operators known to you. We can also help you – get in touch with your nearest sales office. By agreement we will take packing material back, if it is sorted. You must bear the costs of transport. For packing material that is returned to us unsorted or which we are not obliged to accept, we shall have to invoice you for any costs incurred.

Components used in life-support devices or systems must be expressly authorized for such purpose! Critical components ¹, may only be used in life-support devices or systems ² with the express written approval of OSRAM OS.

¹ A critical component is a component used in a life-support device or system whose failure can reasonably be expected to cause the failure of that life-support device or system, or to affect its safety or effectiveness of that device or system.

² Life support devices or systems are intended (a) to be implanted in the human body, or (b) to support and/or maintain and sustain human life. If they fail, it is reasonable to assume that the health of the user may be endangered.